

1230s

mm.130x30

Cod. C10S1230 xxx00

Disponibile in 11 finiture. Vedi aletta di copertina.
Available in 11 finishes. Please see the inside cover flap.
Disponibile in 11 acabados. Ver en la solapa.

Pack. 6

Cerniere invisibili regolabili per porte
Invisible adjustable hinges for doors
Bisagras invisibles ajustables para puertas

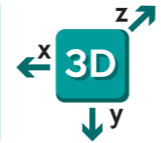

MAINTENANCEFREE

CARATTERISTICHE:

- Realizzata in zama in 11 diverse finiture
- Adatta per ante con spessore minimo di 35 mm
- Range di reversibilità elevato: centrale per ante da 35 a 45 mm di spessore
- Adatta in caso di uso di battiscopa o rivestimento fino a 15,5 mm
- Lunghezza totale 130 mm
- Profondità solo **21 mm**
- Regolazione tridimensionale S.T.A.R.S.
- Portata fino a 70 kg
- Easy installation e simmetria di cava
- Rivista in estetica e funzionalità: più elegante e resistente all'ossidazione grazie alla nuova cassa esterna in zama zincata. Snodo evoluto per una migliore performance: movimento più fluido, deciso, durevole e ora certificato per porte fino a 1000 mm di larghezza

MAIN FEATURES:

- Manufactured in zamak in 11 different finishes
- Suitable for doors of 35 mm min. thickness
- Big reversibility range: central for doors from 35 to 45 mm thick
- Suitable in case of baseboard or claddings till 15,5 mm
- Total length 130 mm
- Depth **21 mm** only
- 3D adjusting system S.T.A.R.S.
- Load capacity up to 70 kg
- Easy installation and slot symmetry
- Revised in aesthetics and operation: now more elegant and resistant to oxidation due to the new external case in zincked zamak. Joint evolved for better performance: smoother movement, extremely precise, durable and now certified for doors up to 1000 mm wide

CARACTERÍSTICAS:

- Fabricada en zamak en 11 acabados diferentes
- Adapta para puertas con un espesor mínimo de 35 mm
- Grande rango de reversibilidad: central para puertas desde 35 hasta 45 mm de espesor
- Adapta en casos de zócalos u revestimientos hasta 15,5 mm
- Longitud total 130 mm
- Profundidad de solamente **21 mm**
- Ajuste en 3D S.T.A.R.S.
- Capacidad de carga hasta 70 kg
- Easy installation y simetría de corte
- Revisada en estética y funcionalidad: ahora más elegante y resistente a la oxidación gracias a la nueva carcasa exterior en zamak zincado. Mecanismo evolucionado para un mejor rendimiento: movimiento más fluido, determinado, duradero y ahora certificada para puertas de hasta 1000 mm de ancho

Misure della cava
Slot measurement
Medidas de corte

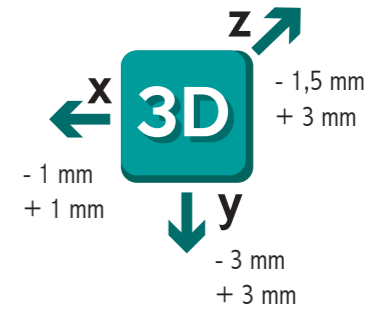
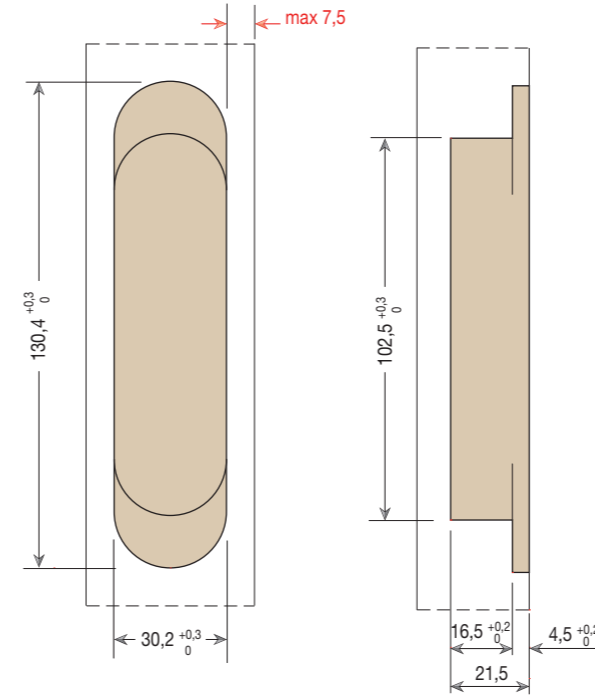

REVERSIBILITÀ - REVERSIBILITY - REVERSIBILIDAD

Reversibile per porte da 35 mm a 45 mm di spessore
Reversible for doors from 35 mm to 45 mm thick
Reversible para puertas de 35 mm hasta 45 mm de espesor

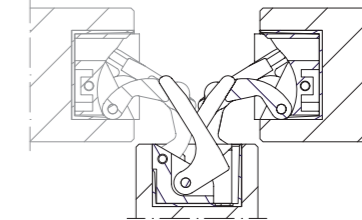

Sezione porta
Door cross-section
Sección de puerta

| A | B |
|------|-----|
| 15,5 | 2,5 |
| 14,5 | 3 |
| 13,5 | 3,5 |
| 12 | 4 |
| 10 | 4,5 |
| 8 | 5 |

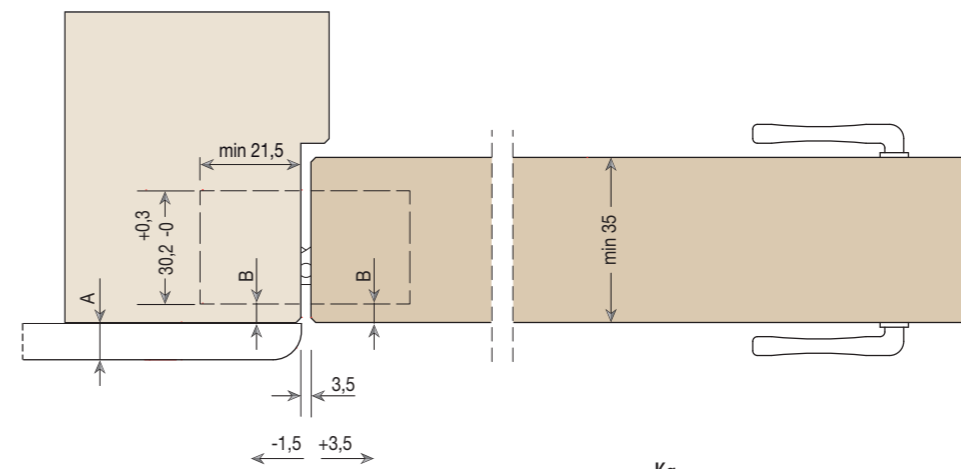

**SCHEMA DI PORTATA
LOAD CAPACITY CHART
TABLA DE CAPACIDAD DE CARGA**

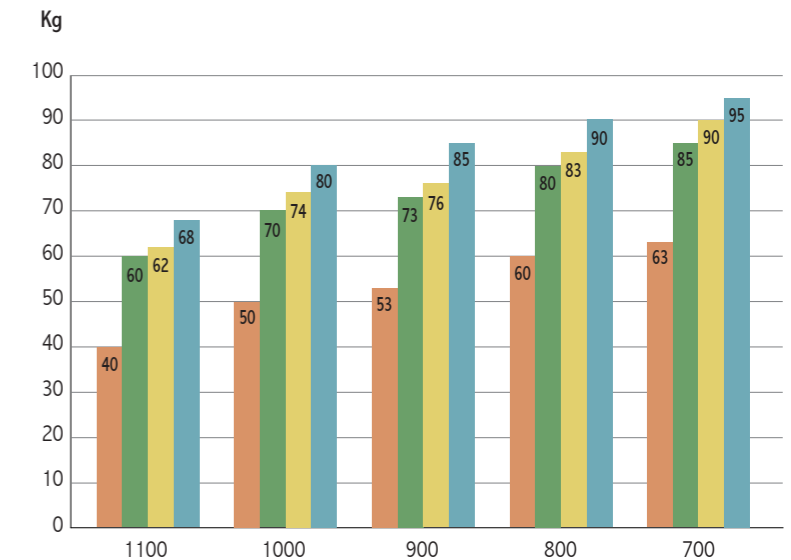
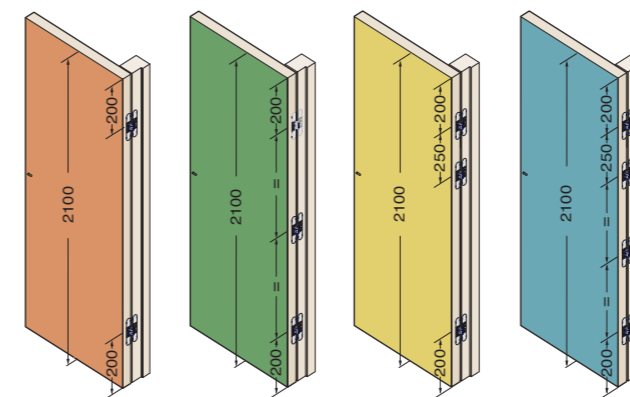

Altezza porta 2100 mm; per H. > 2100 o per utilizzi con chiudiporta, consultare pag.57
Door Height 2100mm; for H>2100 or for doorclosers devices please see pag.58
Altura puerta 2100mm; para H>2100 o para usos con cierrapuertas, consultar pag.59

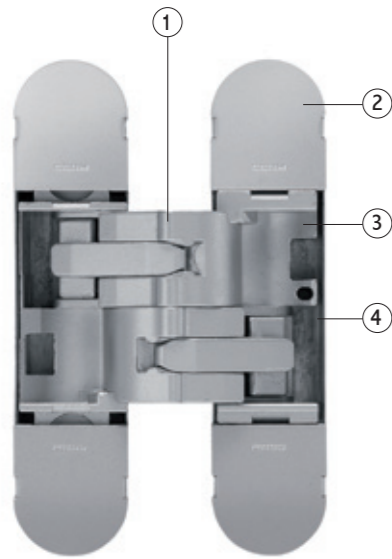

- 1 Snodo realizzato in Zama
Machanism manufactured in zinc-alloy
Mecanizado fabricado en zamak
- 2 Covers in acciaio galvanizzato
Galvanized steel covers
Cover en acero galvanizado
- 3 Gabbia interna in Zama
Zinc-alloy internal body
Caja interna en zamak
- 4 Gabbia esterna in Zama
Zinc-alloy external body
Caja externa en zamak

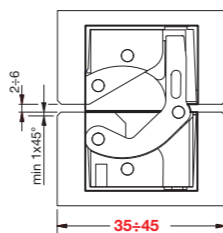
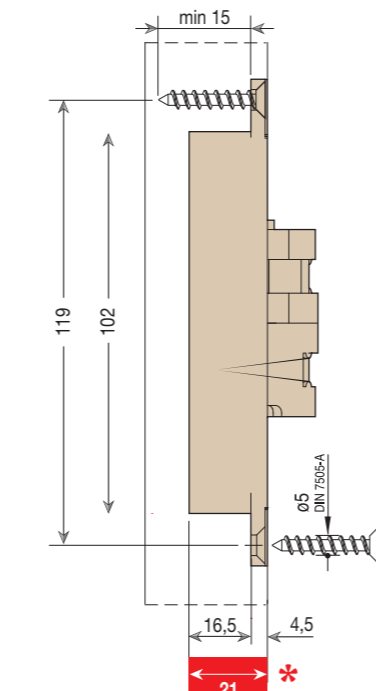
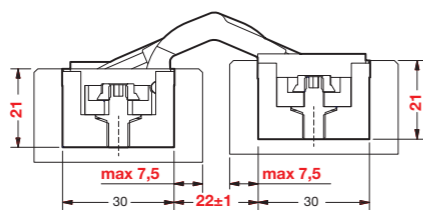
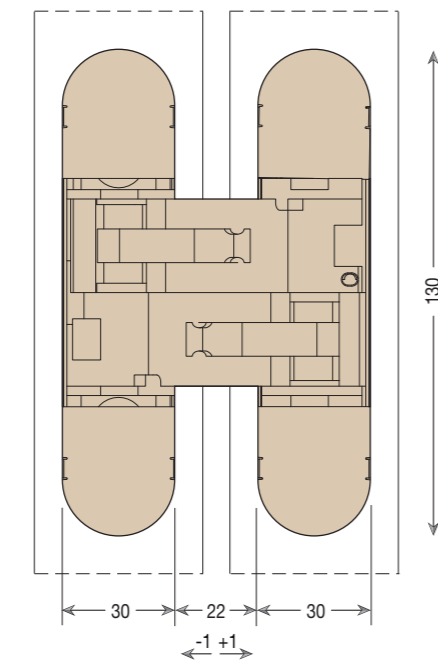

* Profondità di cava contenuta - Small drilling depth - Baja profundidad de corte



Linee guida di regolazione

Adjustment guidelines
Guía general de ajuste

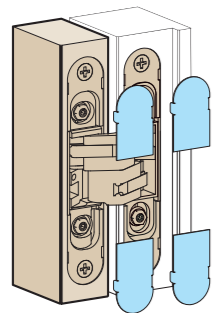

- 1131s
- 1230s
- 1130s
- 1129
- 1030 inox
- 1330s
- 1235s
- 1329
- 1229

Cerniere invisibili regolabili per porte
Invisible adjustable hinges for doors
Bisagras invisibles ajustables para puertas

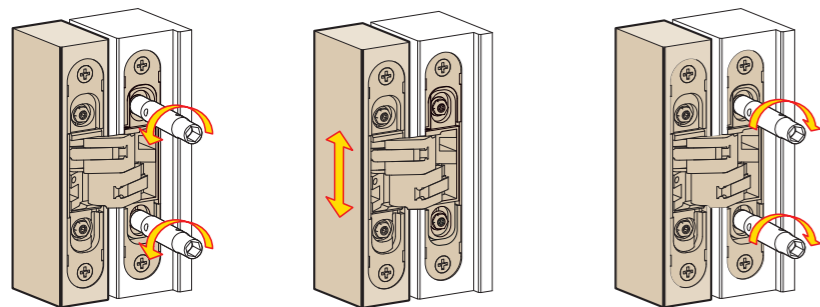
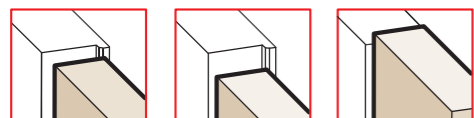
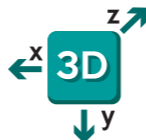

Regolazione verticale
Vertical adjustment
Ajuste vertical

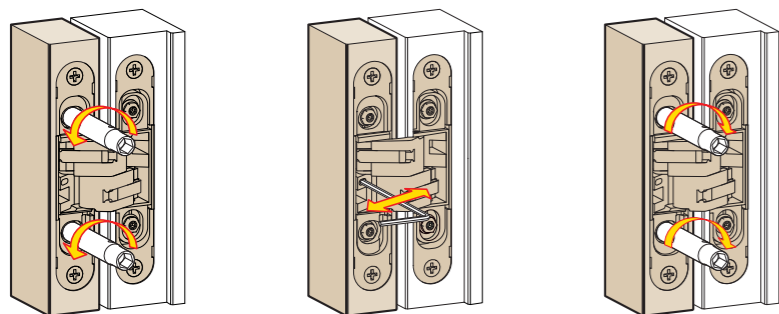
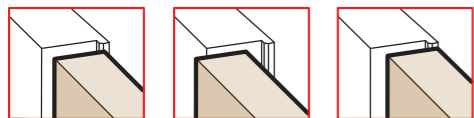
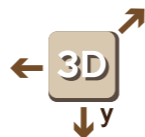

Regolazione orizzontale
Horizontal adjustment
Ajuste horizontal

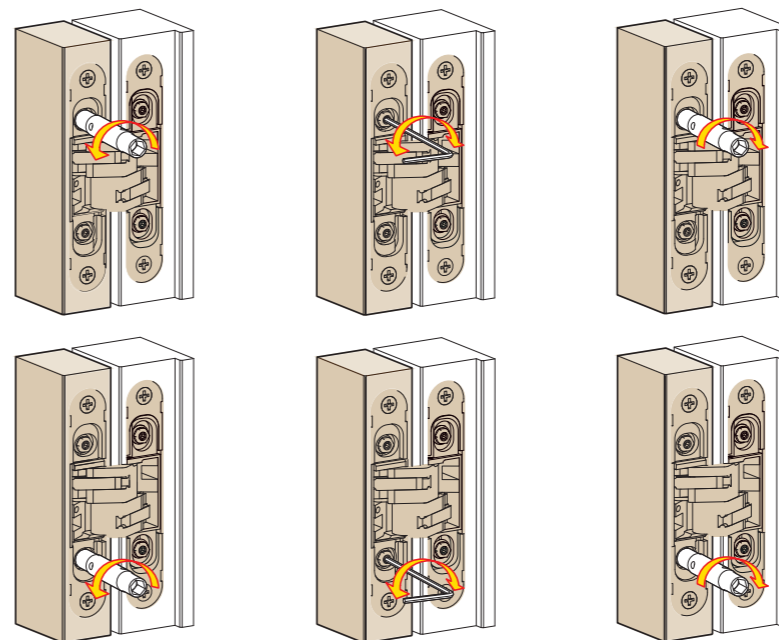
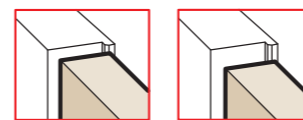
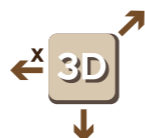

Regolazione in profondità
Depth adjustment
Ajuste de profundidad

